



INSTALLATION INSTRUCTIONS

DISC BRAKE CONVERSION KIT A120

1964-1/2 - 66 Ford & Mercury

Thank you for choosing STAINLESS STEEL BRAKES CORPORATION for your braking needs. Please take the time to read and carefully follow these instructions to insure the ease of your installation as well as the proper performance of the complete system.

Before beginning your installation, please verify you have received all the parts indicated on the packing slip. If you believe anything to be missing or incorrect, please call our Customer Service Department at 716-759-8666.

To assure your installation will go safely and smoothly, have the following items on hand to assist you:

JACK & JACK STANDS
TORQUE WRENCH
TUBE WRENCHES
MALLET
WHEEL BEARING GREASE

LUG WRENCH
SOCKET SET
WRENCH SET
BRAKE FLUID
BRAKE CLEANER

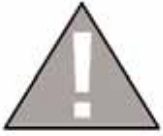

THIS KIT IS DESIGNED FOR CARS WITH V-8 SPINDLES (5-LUG WHEELS) ONLY AND WILL NOT FIT CARS WITH 6 CYLINDER (4-LUG WHEELS) SPINDLES.

TIP: BEFORE BEGINNING INSTALLATION, SPRAY ALL FITTINGS AND FASTENERS WITH PENETRATING OIL.

Front Drum Brake Removal

- 1) Raise the car until the wheels and tires clear the floor and support the car on jack stands. Remove the wheel covers or hub caps and remove the wheel and tire assemblies from the drums.
- 2) Remove the grease cap from the hub. Remove the cotter pin, nut lock, adjusting nut, and flat washer from the spindle. Remove the outer bearing.
- 3) Pull the hub and drum assembly from the spindle. If the brake drum will not come off easily, retract shoes by inserting a narrow screwdriver through the brake adjusting slot in the backing plate and disengage the adjusting lever from the adjusting screw. While holding the adjusting lever away from the adjusting screw, back off the adjuster.
- 4) Drain system of all the brake fluid as follows:
 - a) Remove master cylinder cover. Use a syringe to remove as much fluid from the master cylinder reservoir as possible.
 - b) Attach hoses to front bleeder screws and place other end of hose in a container. Open bleeder screw.



BE CAREFUL NOT TO GET BRAKE FLUID ON THE PAINT. IT CAN CAUSE SEVERE DAMAGE!!

- c) When fluid stops draining, disconnect the flexible hoses from the rigid brake line at the frame and remove horseshoe clips. Use plenty of penetrating oil between the tube nut and the mating fitting. We strongly recommend the use of a tube wrench available from any tool supply store including Sears.
- 5) Remove drum brake as follows:
 - a) Remove flexible hose from the back of both brake cylinders and remove brake cylinder.
 - b) Remove entire drum brake assembly as a unit by removing the four (4) bolts attaching the backing plate to the spindle flange. Discard assembly.
- 6) Installation of Conversion kit (refer to Figure I)
 - a) Install caliper mounting bracket followed by rotor splash shield (over gasket, if there) on spindle. Make sure mounting bracket bosses face toward inside of car and bracket and shield are for the correct side of car (marked left or right). NOTE: Calipers will mount towards front of car.
 - b) Attach shield and bracket to spindle with grade 8 bolts supplied in kit from the outside in so the head of the bolt is on the outside. Secure with locknuts and torque to 35-45 ft./lbs.
- 7) Rotors and Bearings (refer to figure II)
 - a) Remove the protective coating from the new rotor with brake cleaner (available at most parts stores).
 - b) Pack the inner (larger) bearing with wheel bearing grease, and place in inner cup (which is already in the rotor assembly). Pack grease lightly between the

lips of the grease seal and then install seal. Use a soft mallet or a piece of wood so as not to distort the seal.

- c) Install the rotor and hub assembly on the spindle.
- d) Pack and install the outer wheel bearing, washer and adjusting nut.
- e) The wheel bearing adjustment as follows is especially important with disc brakes: Rotate rotor while torquing spindle nut to 17-25 ft.-lbs. Back off the adjusting nut 1/2 turn and retighten to 10-15 in.-lbs. Selectively position nut retainer on adjusting nut so that a set of slots are in line with the cotter pin hole. Adjusting nut should not be rotated during this operation. Lock adjusting nut and retainer with cotter pin and install grease cap.



FOR THE BALANCE OF THESE INSTRUCTIONS, BE CAREFUL THAT ALL HYDRAULIC COMPONENTS ARE KEPT CLEAN AND FREE OF DEBRIS INSIDE AND OUT. REMEMBER; DIRT IS THE ENEMY OF HYDRAULIC SYSTEMS, AND WE WILL NOT BE RESPONSIBLE FOR SYSTEM FAILURES DUE TO AN UNCLEAN INSTALLATION !

8) Caliper Installation

- a) Place pads in caliper (lining material should face each other).
- b) Install stainless steel pad retaining splash shield and secure the shield to the caliper with the stainless retaining bolts and lock washers supplied. Torque bolts to 7-11 ft./lbs.
- c) Connect flexible brake lines to the caliper with one (1) copper washer between the hose fitting and the caliper.
- d) Slide caliper over rotor and install the caliper mounting bolts and torque to 45-60 ft/lbs. Check to insure that the rotor runs squarely and centrally between the two bosses of the caliper. There should also be approximately 0.090-0.120 inch clearance between the caliper body and the rotor outside diameter. Make sure bleeder screws point up.

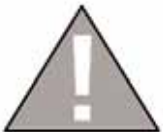

IF CALIPER DOES NOT SLIDE EASILY INTO PLACE OR DOES NOT LINE UP CORRECTLY WITH MOUNTING BRACKET, MINOR TRIMMING OF THE SPLASH SHIELD MAY BE REQUIRED. IF TRIMMING IS REQUIRED, IT SHOULD ONLY BE DONE ON THE TWO EDGES OF THE SHIELD THAT ARE ADJACENT TO THE CALIPERS.

- e) Attach caliper flex line to frame (12 point bracket) and push horseshoe clip over end of hose to retain it.
- f) With both front wheels off the ground, turn wheels through a full left to right turn to insure that the hoses do not twist or take a double bend. If hoses do not bend correctly, remove them from the 12 point bracket and reorient them so that they bend with a minimum of twisting. Failure to complete this part of the installation may cause brake lockup in service since the thin wall interior hose may collapse and restrict the fluid from relieving caliper line pressure when the brake pedal is released.

- 9) Remove master cylinder, booster and line to distribution block
 - a) Remove and discard brake line from master cylinder to distribution block.
 - b) Remove the fastener that secures the pushrod to the brake pedal and the fasteners that secure the master cylinder or booster/master to the firewall. The unit can then be lifted out of the engine bay as one piece including the pushrod.
 - c) Using a tube wrench, disconnect but do not remove the left and right front steel lines from the original distribution block. Now the original distribution block can be removed and discarded.

10) Master Cylinder and Distribution Block Installation



THE MASTER CYLINDER MUST BE BENCH BLEDED BEFORE INSTALLATION. FOR PROPER BENCH BLEEDING PROCEDURE, SEE THE ATTACHED PAGE.

- a) Pushrod
 - 1) If your car is a 64 1/2-66 and was originally equipped with power drum brakes, you must discard the booster and run the new master cylinder non-power. There is not enough room between the firewall and the shock tower to allow for a power booster and a master cylinder. For this reason, power disc brakes were not available from the factory on the 64-1/2 through 66 Mustangs. In this case you will require an adjustable pushrod SSBC part #A21161 which is available at an additional cost.
 - 2) If your car was non-power then you will reuse the pushrod from your old master cylinder. You must first remove the snap ring from the back of the master cylinder and pull the piston and pushrod out of the back of the master cylinder. Once the piston is out, you must then secure it in a vice and, using a hacksaw, cut a slot through the side of the piston parallel to and in line with the pushrod. When you get about half way through the piston, you will cut through the clip and the pushrod will slide out of the piston.
- b) Slide the pushrod into the back of the master cylinder and slide the old rubber dust boot over the pushrod and the back of the master cylinder.



TIP: A DAB OF SILICONE ON THE END OF THE PUSHROD WILL SECURE THE PUSHROD INSIDE THE PISTON.

- c) Install and torque the mounting bolts to 6-12 ft/lbs.
- d) Connect the new stainless steel brake line to the bottom master cylinder outlet so that the loop in the line is up.
- e) Connect the other end of the new brake line to the new three port distribution block supplied in the kit so the right angle bracket of the distribution block is up and facing the fender wall.
- f) Drill or punch hole in the fender wall (if not there) and secure bracket to fender wall with 1/4 in sheet metal hex head screw.
- g) Attach left front and right front factory brake lines to appropriate of distribution block ports.

- 11) Proportioning Valve Installation
 - a) Locate position of adjustable proportioning valve on fender wall between distribution block and fender wall. On some cars there will be a window in the fender wall for the original production valve.
 - b) 1964-1/2 Mustangs used a “Y” fitting between the upper port of the master cylinder and the “IN” port of the proportioning valve. The branch port of the “Y” fitting containing a pressure switch for the rear stop lights. This arrangement located on the original installation can be reused. (A “T” fitting can also be used in place of the “Y” fitting.
 - c) Attach and form straight length of pre-flared tubing supplied with kit between the upper port of the master cylinder or “Y” fitting to the “IN” port of the proportioning valve. Loop extra line in a similar manner as the other stainless steel line.
 - d) Rebend and install brake line from rear brakes to “OUT” port of proportioning valve. NOTE: Two brass adapter fittings are provided (for 3/16 lines). These should be installed into the proportioning valve.
- 12) Filling and Bleeding system
 - a) It is advisable to replace the brake fluid if the color is brown or muddy. This is due to water that has been absorbed by the fluid which will eventually corrode the brake lines and master cylinder. This absorbed moisture can also cause a vapor lock situation under extreme braking conditions. Flush system with clean brake fluid and replace with a good grade of disc brake fluid. DOT 3 or DOT 4 fluids are acceptable.
 - b) The simplest and most effective way to bleed your brakes is to use the gravity bleeding approach as follows:
 - 1) With calipers installed, make sure all fittings are tight and master cylinder is topped off.
 - 2) Open one bleeder screw at a time starting at the wheel farthest from the master cylinder and working your way back around the wheel closest to the master. With bleeder screw open, observe bleeder. At first the fluid will begin to escape with intermittent air bubbles. When the air bubbles stop and a steady flow of fluid is observed for several seconds, close the bleeder valve and move on to the next wheel.



MAKE SURE TO KEEP A CLOSE WATCH OVER THE FLUID LEVEL INSIDE THE MASTER CYLINDER DURING THE BLEEDING PROCESS. NEVER LET THE RESERVOIR RUN DRY. ALWAYS KEEP IT AT LEAST 1/3 FULL.

- 3) After bleeding both wheels and topping of the master cylinder make 20-30 applications of the brake pedal. If a hard pedal is experienced, no further bleeding is required. If pedal is spongy, repeat bleeding process until a hard pedal is achieved.

FINAL INSPECTION

- 13) Once a hard pedal is achieved, all fittings and connections must be inspected to make sure there are no leaks. Also check the level in both reservoirs of the master cylinder and top off, if needed.

- 14) Put wheels back on the car and turn wheel by hand to insure that the wheel spins freely and does not interfere with any brake components. If any interferences are detected, DO NOT drive vehicle until problem can be identified and corrected.

DO NOT DRIVE IN TRAFFIC UNTIL THE BRAKES SAFELY STOP THE CAR A SAFE DISTANCE WITHOUT A SPONGY PEDAL FEEL!

BRAKING TESTS SHOULD ALWAYS BE DONE IN A SAFE OPEN AREA!

TECH LINE -- If technical help is required, please call 716-759-8666.

NOW ENJOY TRUE PERFORMANCE BRAKING!

SSBC
Stainless Steel Brakes Corporation
11470 Main Road
Clarence, NY 14031
(716) 759-8666
Fax: (716) 759-8688
www.ssbrakes.com
tech@ssbrakes.com

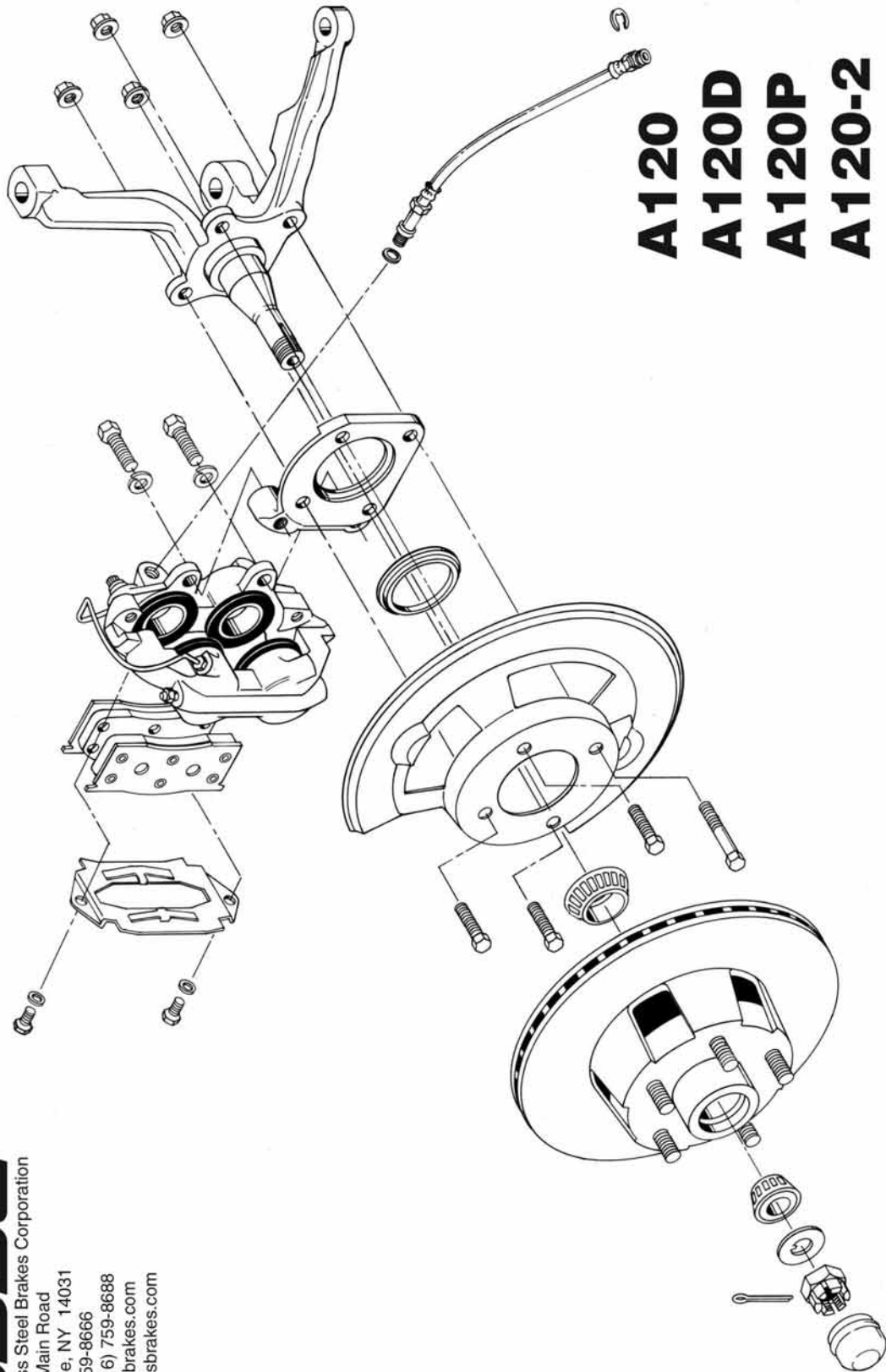

A120
A120D
A120P
A120-2
A120-2P

Typical Brake Line Plumbing Diagram

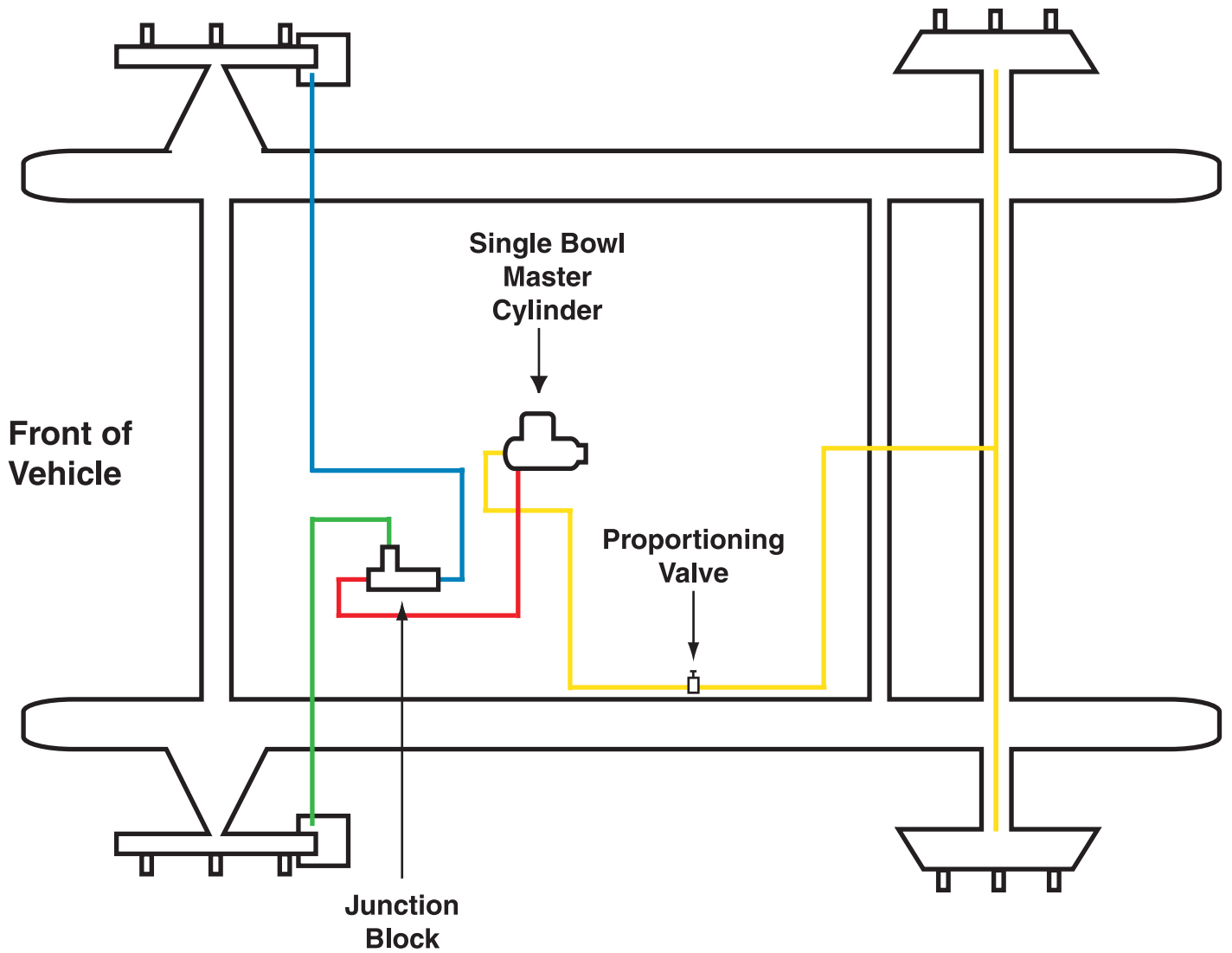

Bottom port of master cylinder goes to junction block, which then feeds the front brakes.

Front port of master cylinder goes to proportioning valve, which then feeds the rear brakes.

POSSIBLE INTERFERENCE BETWEEN SPLASH SHIELD AND CALIPER.

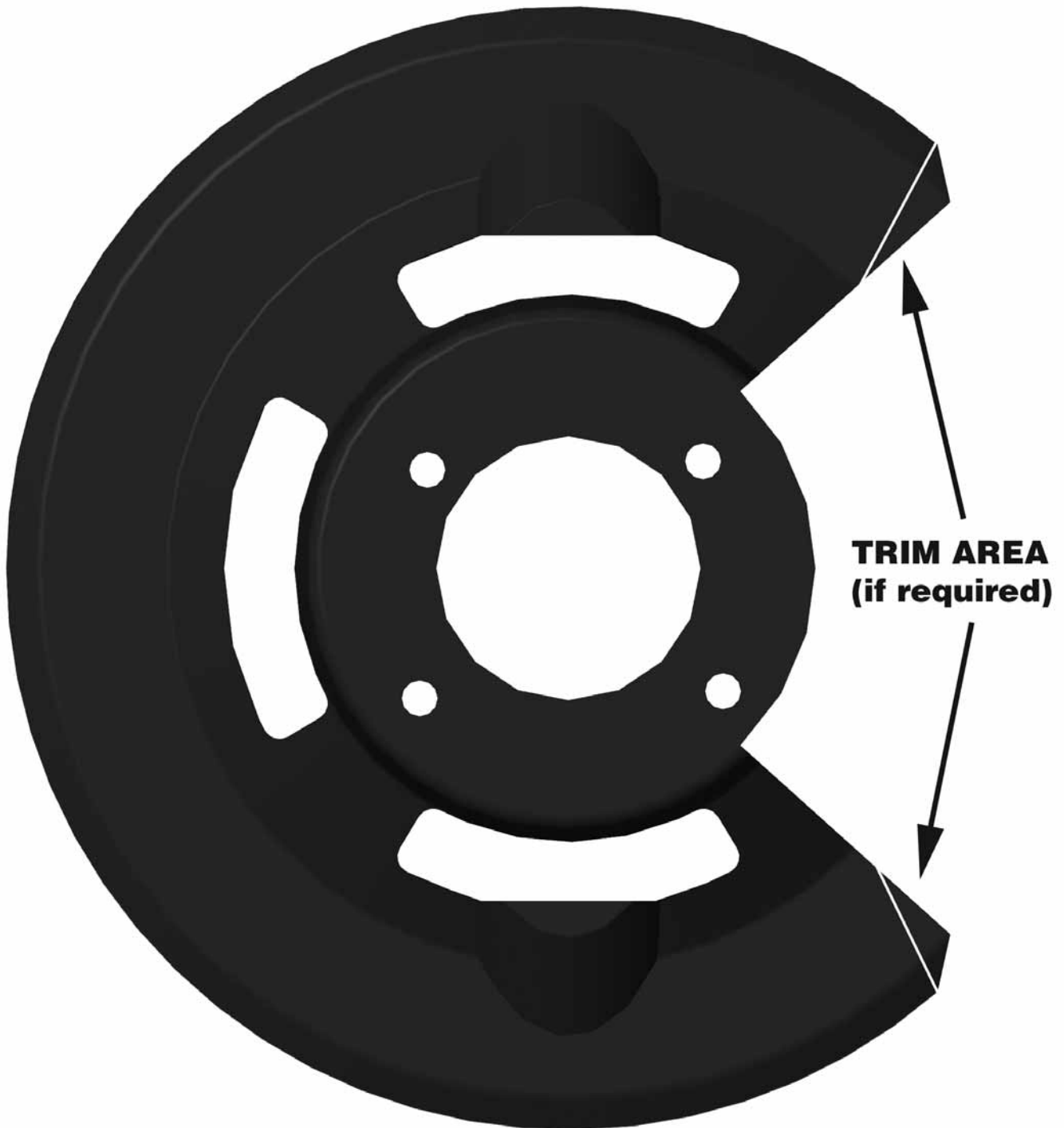

Since this part is made by a vendor beyond our control, we occasionally encounter parts that fall outside ideal tolerance, which will cause interference between the shield and the caliper housing. If you experience this interference, slight trimming of the shields in the marked areas will correct the problem.

We have been told that this situation also occurred during the original production of 1964.5-67 models.

Solutions Guide

to commonly asked questions.

Why is my brake pedal soft?

1) In most cases, Air is trapped in the lines or calipers. Try re-bleeding the system. Do not force new fluid into new brake lines. It may foam and be very difficult to bleed. **Make sure that the bleeder screws on the calipers are facing upward!**

2) If all the air is out of the system, the pushrod from the booster may need adjustment, under the dash, to make it longer. Do not extend it too long or it will not allow the fluid to return, causing brakes to drag. Your pushrod may not be adjustable. If the pushrod can be made longer, try ¼ turn adjustments at a time. SSBC stocks adjustable pushrods for many vehicles. In addition, the pushrod between the Booster and the Master Cylinder may need adjustment. Not all Booster to Master pushrods are adjustable.

3) You may have a bad Master Cylinder. Before you determine this, you should make sure that all the air is out of the system. When installing a new Master Cylinder, always bench bleed first. If you did not, take off the Master Cylinder and bench bleed it. (See Bench Bleeding Instructions below)

Why does the car pull to one side?

The side that the car is pulling to is the caliper that is working. Re-bleed the opposite side and try carefully stopping again.

Why does it feel like there is no Power Assist?

The Booster may not be getting enough vacuum to operate. On some high lift cams, the engine does not develop enough vacuum. The Booster needs at least 16" of vacuum to operate correctly at idle. If you do not have at least 16 inches of vacuum at idle, you may have to add a vacuum pump to your system.

Check for vacuum leaks. There may be leaks in the intake manifold or hoses that would cause low vacuum. The Booster may be bad. Do a vacuum test. If the Booster can retain a vacuum for three (3) minutes after the vehicle is shut off, it is not a bad Booster (refer to steps 1 & 2). All Master Cylinders must be bench bled in a vise before being installed on the vehicle.

How do you bench bleed a Master Cylinder?

Secure one of the ears in a vise so that you can take a large screwdriver and push the piston in. Fill the reservoir with clean fluid. Take a dummy line or our M/C bleeding kit and hook it up to the two ports. Front line to front and rear line to rear reservoirs. Slowly stroke the master and let it return slowly. You should see many air bubbles in the fluid. Repeat this step until you do not see any more air bubbles. SSBC recommends ten (10) slow pumping strokes after you see no more air bubbles. This will insure a good hard pedal. (See SSBC part #0460 Instruction Sheet)

What is the best pad for my vehicle?

Your choice of pads should be determined by how and where you drive the vehicle. If you drive in heavy stop and go traffic you would need a different pad than someone who is road racing. Contact SSBC for the correct application.

How often should brake fluid be changed? (street application only, not racing)

When brake fluid turns brown, it is time to change the fluid. The brown color indicates that the fluid has absorbed water and dirt. D.O.T. #3 & #4 fluids absorb water. Silicone brake fluid is not for track racing.

How can I tell which reservoir is the front or rear of the Master Cylinder?

The front reservoir is usually larger than the rear. In some cases, they are the same size. As a rule, for GM cars & trucks, the rear reservoir is for the rear brakes. On Ford cars & trucks, the front reservoir is for the rear brakes. On front wheel drive vehicles, the brakes are split diagonally. Each bowl of the master cylinder services one front wheel and one rear wheel. This will be important if you are installing a distribution block, proportioning valve, or residual valve. Hint: The larger bowl will feed the disc brakes.

Where is the best place to install a proportioning valve?

The best place to install a proportioning valve is after the distribution block. **Do Not install it between the Distribution Block and the Master Cylinder.** You will not be able to get a hard pedal. Anywhere after the Distribution Block and before the rear flex hose is acceptable for installation.

Why should the flex hoses be replaced? They look O.K. from the outside.

Flex hoses should be replaced every time the calipers are serviced. They flex up and down, just like a shock absorber. They are also under high pressure internally. Flex hoses have a rubber liner that will collapse over time. If it does collapse, it will act as a check valve and not allow fluid to return to the Master Cylinder.

Will my pedal get harder by replacing the flex hoses?

No. When the flex hoses are replaced, re-bleed the brake system. Normally what happens is that bleeding causes a harder brake pedal. A better bleeding job and taking your time will result in the same situation.

Are the rubber flex hoses expanding causing a soft pedal?

Not likely. A soft pedal is usually a sign of air in the system due to poor bleeding. Flex hoses have nylon webbing that is molded into the internal rubber. It is very strong and will hold up to 3,000 P.S.I. Installing braided stainless steel hoses is not necessary; it only improves appearance.

How much brake pressure does it take to stop my vehicle?

Most vehicles, power or non power brake, develop 1,200 P.S.I. When you panic stop or jump on the brakes hard, a surge of 1,400 P.S.I. can be achieved. If a factory proportioning valve installed on the vehicle, the rear brakes are only developing 600 – 700 P.S.I. Drum brakes require lower pressure because they grab more quickly. When rear disc brakes are installed, the rear brake pressure may be increased to 800 – 1,000 P.S.I. or more. A good way to check the pressures and to see if the system is working correctly, use a pressure gauge screwed into the bleeder port (SSBC part # A1704). A vehicle with less than 600 P.S.I will not stop!

How tight should the wheel bearings be?

The front bearings should always be torqued. Not just hand tightened. Bearings usually require 12-15 Ft./Lbs. of torque. Then you will probably need to back off a little to align the cotter pin hole. Do Not over tighten; the bearing life will be shortened. This procedure only applies to rear wheel drive vehicles with separate bearings and races. On vehicles with one piece sealed bearing assemblies or hub assemblies, refer to a service manual.

What type of differential fluid should I use in my rear axle?

If you have positraction, use a Hypoid or Limited Slip additive that is designed for your particular rear end. If you do not have positraction, any type of 80 –90 weight gear lube is acceptable. Fluid should be changed often if you are trailering or any type of extreme usage. This fluid does brake down with time and usage.

SSBC Kit #	SSBC Pad #	FMSI #	SSBC Kit #	SSBC Pad #	FMSI #	SSBC Kit #	SSBC Pad #	FMSI #	SSBC Kit #	SSBC Pad #	FMSI #
A109	1012	D-8	A112-2	1047	D-347	A121P-A	A1033	*	A125-5	1047	D-347
A109-1	10108	D-531	A112-3	1071	D-412	A121P-M	A1033	*	A125-6	1047	D-347
A109AF	10128	D-531	A112-4	1047	D-347	A123	1050	D-52	A125-7	1047	D-347
A109AR	10128	D-531	A112-5	1061-1	D199	A123-1	1050	D-52	A125-8	10128	D-531
A109S	1012	D-8	A112-6	10128	D-531	A123-13	1095	D-731	A125-9	10128	D-531
A110	1049	D-204	A112-7	1071	D-412	A123-14	1095	D-731	A125-F	1047	D-347
A110-10	10129	D-43	A112-8	10128	D-531	A123-15	10116	D-749	A125P	1047	D-347
A110-11	10113	D-154	A112-9	1015	D-52	A123-16	10116	D-749	A126	1070P	D-413
A110-12	10113	D-154	A112-93	1047	D-347	A123-17	1095	D-731	A126-1	1047	D-347
A110-13	1015	D-52	A113	1071	D-412	A123-18	1095	D-731	A126-10	1015	D-52
A110-14	10135	D-137	A113-1	1071	D-412	A123-1A	1015	D-52	A126-11	1015	D-52
A110-15	1095	D-731	A113-10	1071	D-412	A123-1C	1050	D-52	A126-12	1015	D-52
A110-16	10128	D-531	A113-11	1015	D-52	A123-2	1071	D-412	A126-13	1094A	D-370
A110-17	10128	D-531	A113-12	1095	D-731	A123-3	1050	D-52	A126-14	1094A	D-370
A110-18	1047	D-347	A113-4	10128	D-531	A123-3A	1015	D-52	A126-15	1094A	D-370
A110-19	10113	D-154	A113-5	1015	D-52	A123-4	1050	D-52	A126-16	1094A	D-370
A110-2	1047	D-347	A113-6	10128	D-531	A123-4A	1015	D-52	A126-17	1094A	D-370
A110-3	10128	D-531	A113-7	10128	D-531	A123-5	1050	D-52	A126-18	1015	D-52
A110-4	10128	D-531	A113-8	1070	D-413	A123-58	1050	D-52	A126-19	1094A	D-370
A110-5	1015	D-52	A113-9	10128	D-531	A123-58A	1015	D-52	A126-2	1047	D-347
A110-6	1015	D-52	A114	1047	D-347	A123-59	1050	D-52	A126-20	1015	D-52
A110-7	10110	D-11	A115	1047	D-347	A123-59A	1015	D-52	A126-21	10129	D-43
A110-8	10110	D-11	A116	1049	D-204	A123-5A	1015	D-52	A126-22	10128	D-531
A110-9	10129	D-43	A117	1047	D-347	A123-6	1071	D-412	A126-23	10128	D-531
A111	1049	D-204	A117-1	1047	D-347	A123-67	1071	D-412	A126-24	10128	D-531
A111-10	1015	D-52	A117-10	10113	D-154	A123-68	1071	D-412	A126-25	10128	D-531
A111-11	1015	D-52	A117-11	1095	D-731	A123-69	1071	D-412	A126-26	10128	D-531
A111-12	10110	D-11	A117-12	1095	D-731	A123-6A	1071	D-412	A126-27	10128	D-531
A111-13	10110	D-11	A117-13	10113	D-154	A123-7	10128	D-531	A126-28	10128	D-531
A111-14	10110	D-11	A117-14	10113	D-154	A123-8	10128	D-531	A126-29	10128	D-531
A111-15	10110	D-11	A117-15	10113	D-154	A123-9	10128	D-531	A126-3	A1094B	*
A111-16	10129	D-43	A117-2	1047	D-347	A123-A	1015	D-52	A126-30	10128	D-531
A111-17	10129	D-43	A117-3	1071	D-412	A124	1047	D-347	A126-31	10128	D-531
A111-18	10129	D-43	A117-4	1071	D-412	A125	1047	D-347	A126-32	1015	D-52
A111-19	10129	D-43	A117-5	10128	D-531	A125-1	1047	D-347	A126-33	10128	D-531
A111-2	1047	D-347	A117-6	10128	D-531	A125-10	10128	D-531	A126-34	10128	D-531
A111-20	10113	D-154	A117-7	10128	D-531	A125-11	10128	D-531	A126-35	10128	D-531
A111-21	10113	D-154	A117-8	1047	D-347	A125-12	10128	D-531	A126-37	1095	D-731
A111-22	10113	D-154	A117-9	1095	D-731	A125-13	10128	D-531	A126-38	1095	D-731
A111-23	10113	D-154	A118	1049	D-204	A125-14	1015	D-52	A126-39	1095	D-731
A111-24	1015	D-52	A120	A1033	*	A125-15	1015	D-52	A126-4	A1094B	*
A111-25	10135	D-137	A120-10	10128	D-531	A125-16	1015	D-52	A126-40	10126	D-834
A111-26	1095	D-731	A120-11	10128	D-531	A125-17	1015	D-52	A126-41	10126	D-834
A111-27	10128	D-531	A120-12	10128	D-531	A125-18	10110	D-11	A126-46	10126	D-834
A111-28	1015	D-52	A120-2	10110	D-11	A125-19	10110	D-11	A126-5	1047	D-347
A111-29	10129	D-43	A120-2P	10110	D-11	A125-1F	1047	D-347	A126-51	1047	D-347
A111-3	10135	D-137	A120-2PO	10129	D-43	A125-2	1047	D-347	A126-6	1050	D-52
A111-30	1095	D-731	A120-2PPO	10129	D-43	A125-20	10110	D-11	A126-61	1050	D-52
A111-31	10128	D-531	A120-3	10128	D-531	A125-21	10128	D-531	A126-7	1094	D-369
A111-32	10128	D-531	A120-4	10144	D-289	A125-22	10129	D-43	A126-71	1094	D-369
A111-33	10128	D-531	A120-5	10144	D-289	A125-23	10129	D-43	A126-71A	A1094	*
A111-4	10128	D-531	A120-6	10128	D-531	A125-24	10129	D-43	A126-7A	A1094	*
A111-5	10128	D-531	A120-7	10128	D-531	A125-25	10129	D-43	A126-8	1094	D-369
A111-6	10128	D-531	A120-7A	10128	D-531	A125-26	10113	D-154	A126-9	1049	D-204
A111-7	10128	D-531	A120-7M	10128	D-531	A125-27	10113	D-154	A127	1047	D-347
A111-8	A1015-3	*	A120-8	10128	D-531	A125-28	10113	D-154	A127-1	10128	D-531
A111-9	1015	D-52	A120-9	10128	D-531	A125-29	10113	D-154	A127-2	1070	D-413
A112	1047	D-347	A120D	A1033	*	A125-29	1047	D-347	A127-3	1071	D-412
A112-1	1047	D-347	A120P	A1033	*	A125-30	10113	D-154	A127-4	10128	D-531
A112-11	1095	D-731	A121	A1033	*	A125-31	1015	D-52	A127-5	10128	D-531
A112-12	1095	D-731	A121-2P	10110	D-11	A125-32	1015	D-52	A127-6	1015	D-52
A112-13	10113	D-154	A121-2PA	10110	D-11	A125-33	10135	D-137	A127-7	1047	D-347
A112-14	1047	D-347	A121-2PAPO	10110	D-11	A125-34	1095	D-731	A127-8	1015	D-52
A112-15	1047	D-347	A121-2PM	10110	D-11	A125-35	10128	D-531	A127-9	1047	D-347
A112-16	1095	D-731	A121-2PMPO	A10129	*	A125-36	10128	D-531	A128	1047	D-347
A112-17	10133-1	D-784	A121P	A1033	*	A125-4	1047	D-347	A128-1	1047	D-347

***RE-ORDER PADS DIRECTLY FROM SSBC**

SSBC Kit #	SSBC Pad #	FMSI #	SSBC Kit #	SSBC Pad #	FMSI #	SSBC Kit #	SSBC Pad #	FMSI #	SSBC Kit #	SSBC Pad #	FMSI #
A128-2	1047	D-347	A141	1084-2	D-154	A148-7G	10110	D-11	A164-12	10128	D-531
A128-3	1049	D-204	A141-1	1071	D-412	A148-7GE	10129	D-43	A164-13	10129	D-43
A128-4	1047	D-347	A142	1050	D-52	A148-A	10113	D-154	A164-14	10128	D-531
A128-5	1049	D-204	A142-1	1071	D-412	A150	1047	D-347	A164-15	10126	D-834
A128-6	1047	D-347	A143	1084-2	D-154	A150-1	1047	D-347	A164-16	10128	D-531
A128-7	1047	D-347	A143-1	1071	D-412	A150-2	1047	D-347	A164-17	10126	D-834
A129	1050	D-52	A143-5	1084	D-154	A151	1071	D-412	A164-2	10128	D-531
A129-1	1050	D-52	A143-58	1084	D-154	A151-1	10113	D-154	A164-3	10128	D-531
A129-10	10128	D-531	A143-59	1084	D-154	A151-2	1095	D-731	A164-4	10128	D-531
A129-12	1050	D-52	A144	1084-2	D-154	A152	A1033	*	A164-5	10128	D-531
A129-13	1050	D-52	A144-1	1071	D-412	A152-1	10110	D-11	A164-6	10128	D-531
A129-1A	1015	D-52	A145	1084-2	D-154	A153	A1033	*	A164-7	10128	D-531
A129-2	1050	D-52	A145-1	1071	D-412	A153-1	A1033	*	A164-8	10128	D-531
A129-20	10128	D-531	A146	1071	D-412	A153-2	10110	D-11	A164-9	10128	D-531
A129-22	1095	D-731	A146-1	1084-2	D-154	A153-3	10110	D-11	A165	10128	D-531
A129-23	10128	D-531	A148	1084-2	D-154	A154	A1033	*	A165-1	10128	D-531
A129-24	1095	D-731	A148-1	1084-2	D-154	A154-1	A1033	*	A165-2	1095	D-731
A129-2A	1015	D-52	A148-14	1050	D-52	A154-2	10110	D-11	A165-3	1095	D-731
A129-3	1050	D-52	A148-14A	1015	D-52	A154-3	10110	D-11	A165-4	10133-1	D-784
A129-3A	1015	D-52	A148-15	1050	D-52	A154-4	A1033	*	A166-1	1015	D-52
A129-4	1050	D-52	A148-15A	1015	D-52	A154-5	A1033	*	A166-10	1015	D-52
A129-4A	1015	D-52	A148-16	1050	D-52	A154-6	1095	D-731	A166-13	1015	D-52
A129-5	1071	D-412	A148-16A	1015	D-52	A155	1047	D-347	A166-14	1015	D-52
A129-6	10128	D-531	A148-17	1050	D-52	A155-1	1047	D-347	A166-15	10128	D-531
A129-8	10128	D-531	A148-17A	1015	D-52	A155-2	1047	D-347	A166-16	1015	D-52
A129-A	1015	D-52	A148-18	1050	D-52	A156	A1033	*	A166-17	1015	D-52
A130	1047	D-347	A148-18A	1015	D-52	A156-1	A1033	*	A166-18	10128	D-531
A130-1	1047	D-347	A148-1A	10113	D-154	A156-2	10110	D-11	A166-19	1015	D-52
A130-2	1047	D-347	A148-2	A1033	*	A156-3	10110	D-11	A166-1A	1015	D-52
A132	1046	D-34	A148-22	1050	D-52	A156-4	1095	D-731	A166-2	10128	D-531
A132-1	1046	D-34	A148-23	10110	D-11	A157	1047	D-347	A166-20	1015	D-52
A132-A	1046	D-34	A148-23FS	10110	D-11	A157-1	10128	D-531	A166-21	10108	D-531
A132-M	1046	D-34	A148-23FSE	10129	D-43	A157-2	10128	D-531	A166-22	1047	D-347
A133	1046	D-34	A148-23RS	10110	D-11	A158	1047	D-347	A166-23	A1015-3	*
A133-1	1046	D-34	A148-23RSE	10129	D-43	A158-1	1047	D-347	A166-24	1015	D-52
A133-2	A1033	*	A148-24FSE	10129	D-43	A158-2	1094A	D-370	A166-25	1047	D-347
A133-2P	A1033	*	A148-24RS	10110	D-11	A158-3	1094A	D-370	A166-26	1047	D-347
A133-3	10110	D-11	A148-24RSE	10129	D-43	A158-4	10128	D-531	A166-27	1047	D-347
A133-3P	10110	D-11	A148-25FSE	10129	D-43	A159	10100	D-268	A166-28	1047	D-347
A133-3PO	10129	D-43	A148-25RSE	10129	D-43	A159-1	1094A	D-370	A166-29	1047	D-347
A134	1046	D-34	A148-26	10128	D-531	A160	10128	D-531	A166-3	1015	D-52
A134-1	1046	D-34	A148-26FS	10128	D-531	A160-1	1047	D-347	A166-30	1047	D-347
A134-1P	10110	D-11	A148-26RS	10128	D-531	A160-2	1015	D-52	A166-3A	1015	D-52
A134-1PPO	10110	D-11	A148-27	10128	D-531	A160-3	1015	D-52	A166-4	10128	D-531
A135	1050	D-52	A148-27FS	10128	D-531	A160-4	1047	D-347	A166-5	1015	D-52
A135-1	1094A	D-370	A148-27RS	10128	D-531	A161	1015	D-52	A166-6	1015	D-52
A135-1A	A1094	*	A148-28	10128	D-531	A161-1	1047	D-347	A166-7	1015	D-52
A135-2	1094	D-369	A148-29	10128	D-531	A161-2	1015	D-52	A166-8	1015	D-52
A135-3	10110	D-11	A148-3	A1033	*	A162	1095	D-731	A166-9	10128	D-531
A136	1047	D-347	A148-30	10110	D-11	A162-1	10113	D-154	A167	1015	D-52
A136-1	1047	D-347	A148-30E	10129	D-43	A162-2	1095	D-731	A167-1	1015	D-52
A137	1012	D-8	A148-31	1084-2	D-154	A162-3	10113	D-154	A167-2	10128	D-531
A137-1	1050	D-52	A148-31A	10113	D-154	A163	1015	D-52	A167-3	1015	D-52
A137-1A	1015	D-52	A148-32	1084-2	D-154	A163-1	1047	D-347	A167-4	1015	D-52
A137-2	10128	D-531	A148-32A	10113	D-154	A163-2	1015	D-52	A167-5	10128	D-531
A137-3	1050	D-52	A148-33	1095	D-731	A163-3	1015	D-52	A168	1015	D-52
A137-3A	1015	D-52	A148-34	1095	D-731	A163-4	1047	D-347	A168-1	1015	D-52
A138	1084-2	D-154	A148-4	10110	D-11	A163-5	1015	D-52	A168-10	1015	D-52
A138-1	1084-2	D-154	A148-4E	10129	D-43	A163-6	10113	D-154	A168-11	1015	D-52
A138-1A	10113	D-154	A148-5	10110	D-11	A163-7	10113	D-154	A168-2	10128	D-531
A138-2	1050	D-52	A148-6F	A1033	*	A163-8	10113	D-154	A168-3	1015	D-52
A138-3	1050	D-52	A148-6FE	10129	D-43	A163-9	10113	D-154	A168-4	1015	D-52
A138-4	1050	D-52	A148-6G	A1033	*	A164	10128	D-531	A168-5	10128	D-531
A138-A	10113	D-154	A148-6GE	10129	D-43	A164-1	10128	D-531	A168-6	1015	D-52
A140	1084-2	D-154	A148-7F	10110	D-11	A164-10	10128	D-531	A168-7	1015	D-52
A140-1	10128	D-531	A148-7FE	10129	D-43	A164-11	10128	D-531	A168-8	10128	D-531

***RE-ORDER PADS DIRECTLY FROM SSBC**

SSBC Kit #	SSBC Pad #	FMSI #	SSBC Kit #	SSBC Pad #	FMSI #
A170	1015	D-52	A2350014	10116	D-749
A170-1	10128	D-531	A2350014R	10117	D-750
A171	1015	D-52	A2351000	1015	D-52
A171-1	1015	D-52	A2351001	1015	D-52
A171-2	10128	D-531	A2351002	1015	D-52
A171-3	1047	D-347	A2351003	10100	D-368
A172	1015	D-52	A2351004	1094	D-369
A172-1	1015	D-52	A2351005	1094	D-369
A172-2	1047	D-347	A2351006	1094	D-369
A172-3	1015	D-52	A2351007	1015	D-52
A172-4	1015	D-52	A2351008	10100	D-368
A172-5	1015	D-52	A2351009	1094	D-369
A172-6	1015	D-52	A2351010	1094	D-369
A173	10128	D-531	A2351011	1015	D-52
A173-1	10128	D-531	A2351012	1094	D-369
A173-3	A10135	*	A2351013	1015	D-52
A174	1015	D-52	A2351014	1094	D-369
A174-1	1015	D-52	A2351015	1015	D-52
A180-M	1015	D-52	A2351016	1094	D-369
A180-S	1015	D-52	A2351017	10113	D-154
A181	10113	D-154	A2351018	10113	D-154
A182	10113	D-154	A2351019	10118(F) 10119(R)	D-785(F) D-792(R)
A185-M	1015	D-52	A2351020	10126	D-834
A185-S	1015	D-52	A2351021	10119	D-792
A186-1	A1094	*	A2351022	10118	D-785
A187	1095	D-731	A2351023	10113	D-154
A187-1	1095	D-731	A2351024	10133-1	D-784
A187-2	10126	D-834	A2351025	10118(F) 10143(R)	D-785(F) D-974A(R)
A187-3	10126	D-834	A2351026	10143	D-974A
A187-4	10133-1	D-784	A2351027	10133-1(F) 10134(R)	D-784(F) D-785(R)
A188	10110	D-11	A2351028	10133-1	D-784
A188-1	10110	D-11	A2360000	A1033	*
A189	10110	D-11	A2360001	1046	D-34
A189-1	1095	D-731	A2360002	1046	D-34
A190	A10129	*	A2360003	1066	D-237
A191	10129	D-43	A2360004	1061(F) 1049(R)	D-199(F) D-204(R)
A192	10135	D-137	A2360005	1061	D-199
A193	1095	D-731	A2360006	10103(F) 10104(R)	D-600(F) D-627(R)
A193-1	10133-1	D-784	A2360007	1081(F) 10145(R)	D-412(F) D-627A(R)
A194	1097	D-614	A2360008	1061-1(F) 1047(R)	D-199(F) D-347(R)
			A2360009	10127	D-711
			A2360010	10127	D-711
			A2360011	10137(F) 10104(R)	D-491(F) D-627(R)
			A2361001	10146(F) 10147(R)	D-749(F) D-1012(R)
			A2361002	10146(F) 10147(R)	D-749(F) D-1012(R)
			A2361003	10147	D-1012
			A2370000	1092	D-203
			A2370001	1092	D-203
			A2370002	1093	D-477
			A2370003	1015	D-52
			A2370004	1093	D-477
			A2370005	10111	D-529
			A2370006	1094	D-369
			A2370007	1094	D-369
			A2370008	10111	D-529
			A2370009	10111	D-529
			A2370010	10111	D-529
			A2370011	10114	D-746
			A2370012	10120	D-820
			A2370013	10125	D-702
			A2370014	10125	D-702
			A2370015	1093(F) 10139(R)	D-477(F) D-666(R)
			A2370016	10140(F) 10141(R)	D-790(F) D-791(R)
			A2370017	10142(F) 10141(R)	D-945(F) D-791(R)
			A2380001	10121(F) 10122(R)	D-591(F) D-512(R)
			A2380002	10123(F) 10124(R)	D-592(F) D-592(R)

Short Stop...™ Slotted Rotor Upgrade Kits		
SSBC Kit #	SSBC Pad #	FMSI #
A2350000	10112	D-8
A2350001	1015	D-52
A2350002	1015	D-52
A2350003	10113	D-154
A2350004	1099(F) 1070(R)	D-623(F) D-413(R)
A2350004R	1070	D-413
A2350005	10101(F) 10102(R)	D-294(F) D-295(R)
A2350006	1081(F) 1070(R)	D-412 (F) D-413(R)
A2350007	1081(F) 1070(R)	D-412 (F) D-413(R)
A2350008	1095(F) 1096(R)	D-731(F) D-732(R)
A2350008R	1096	D-732
A2350009	1097(F) 1098(R)	D-614(F) D-628(R)
A2350009R	1097(F) 1098(R)	D-614(F) D-628(R)
A2350010	1015	D-52
A2350012	1015	D-52
A2350013	1081	D-412

***RE-ORDER PADS DIRECTLY FROM SSBC**



Stainless Steel Brakes Corporation

11470 Main Road • Clarence, NY 14031
 Ph: 716-759-8666 Fx: 716-759-8688
 ssbrakes.com • tech@ssbrakes.com

**REPLACEMENT
PARTS
ORDER FORM**

DATE: _____

CUSTOMER # (from receipt): _____

ORDERED BY:
NAME: _____
COMPANY: _____
STREET: _____
CITY: _____ **ST:** _____ **ZIP:** _____
DAY PHONE: _____
FAX: _____
E-MAIL: _____

SHIP TO:
NAME: _____
COMPANY: _____
STREET: _____
CITY: _____ **ST:** _____ **ZIP:** _____
DAY PHONE: _____
FAX: _____
E-MAIL: _____

VEHICLE INFORMATION:
TYPE OF AUTOMOBILE: _____
YEAR _____ **ENGINE:** 4 CYL. 6 CYL. 8 CYL.

TYPE OF DRIVING:
 STREET RACING
 STREET & SLALOM STREET MODIFIED

ORDER INFORMATION:

QUANTITY	PART #	DESCRIPTION	UNIT PRICE	AMOUNT

METHOD OF PAYMENT:

CHECK/MONEY ORDER VISA MASTERCARD DISCOVER AMEX

CREDIT CARD #: _____ **EXP:** _____

SIGNATURE: _____

Total Merchandise	
NY Residents Sales Tax	
Ins. (add \$0.35 per \$100.00)	
UPS Shipping (please call)	
TOTAL	

Price subject to change without notice. Not responsible for typographical errors.

NOTE: Name, address & telephone number must be printed on checks. Driver's License number required for personal checks.

FREE FREIGHT
 IF ORDERED WITHIN 30 DAYS OF INITIAL ORDER
MAIL OR FAX YOUR ORDER!

How and why do I bench bleed a master cylinder?

When installing or replacing a master cylinder, it is critical that all air is removed from the master cylinder. This can easily be done by bench bleeding the master cylinder prior to installation. Using the SSBC master cylinder bleeder kit (#0460):

- 1) Place your master cylinder in a vise by the ears (not body). Make sure it is level.
- 2) Attach a piece of clear plastic hose to the short end of one of the plastic nozzles. Do the same to the other hose and nozzle.
- 3) Clip the plastic bridge to the wall and push the ends of the hose through the holes so they are **SUBMERGED** in the reservoir on either side of the wall.
- 4) Press the tapered end of the nozzle **FIRMLY** into the cylinder port hole with a twisting motion. Repeat this procedure on the other port hole.
- 5) Fill the reservoir with **CLEAN** brake fluid recommended by the manufacturer.
- 6) Using full strokes, push the piston in, then release. Do this until **ALL** the air bubbles have disappeared from the clear plastic hose. **(CAUTION-MASTER CYLINDER WILL NOT BLEED PROPERLY UNLESS HOSES ARE SUBMERGED IN BRAKE FLUID UNTIL THE BLEEDING PROCESS IS COMPLETED.)**

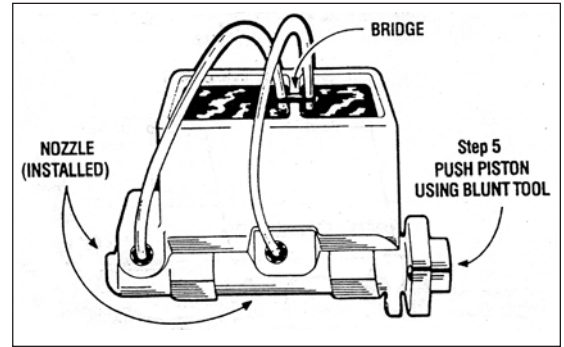

Now mount master cylinder and avoid brake fluid leaking out of front and rear ports during installation.

Bleeding steps for Dual Port Master Cylinder



If you have a master cylinder with dual port holes (4 port holes - 2 on each side), it is necessary to bleed both port sides of the master cylinder. If both sides of the master cylinder are not bled, there will be air trapped in the master cylinder and your brakes will not function properly.

To bleed dual port master cylinders:

- 1) Follow steps 1 - 6 above on the side you will be hooking the brake lines to. Plug the other side.
- 2) Once the air bubbles are no longer visible in the plastic hose, open the bleeder screws in the supplied plugs and allow the mater cylinder to gravity bleed. **DO NOT** push the master cylinder piston in while the plugs are gravity bleeding.
- 3) When clear, steady streams of fluid are coming out of both bleeders, close and tighten the bleeders. Give the master cylinder piston several strokes, making sure there are still no bubbles present in the clear plastic tubes.
- 4) Remove the tubes and plastic fittings and mount the master cylinder on the vehicle being careful not to spill brake fluid on any painted surfaces.

TORQUE SPECIFICATIONS

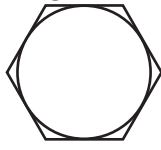
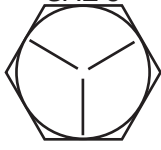
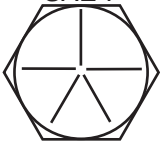
BEFORE DRIVING YOUR VEHICLE, YOU SHOULD CHECK THE TORQUE ON ALL NUTS AND BOLTS IN THE KIT, INCLUDING ANY SLIDER BOLTS ON THE CALIPERS. RE-TORQUE CALIPER BOLTS AFTER 500 MILES. ALL SPECIFICATIONS ARE IN FT-LBS.

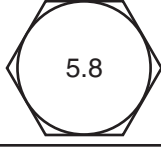
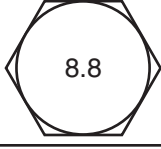
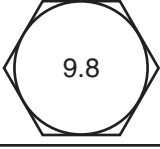
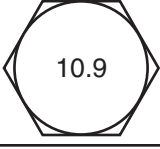
BOLT GRADES				
U.S.				
Metric				
Steel Type	Low Carbon (soft)	Medium Carbon Heat Treat	Medium Carbon Alloy	Medium Carbon Alloy

SAE	Bolt Grade	2	2	5	5	7	7	8	8	Socket Head Cap Screw	Socket Head Cap Screw
Bolt Dia.	Thread per inch	Dry	Oiled	Dry	Oiled	Dry	Oiled	Dry	Oiled	Dry	Oiled
1/4"	20	4	3	8	6	10	8	12	9	14	11
1/4"	28	6	4	10	7	12	9	14	10	16	13
5/16"	18	9	7	17	13	21	16	25	18	29	23
5/16"	24	12	9	19	14	24	18	29	20	33	26
3/8"	16	16	12	30	23	40	30	45	35	49	39
3/8"	24	22	16	35	25	45	35	50	40	54	44
7/16"	14	24	17	50	35	60	45	70	55	76	61
7/16"	20	34	26	55	40	70	50	80	60	85	68
1/2"	13	38	31	75	55	95	70	110	80	113	90
1/2"	20	52	42	90	65	100	80	120	90	126	100
9/16"	12	52	42	110	80	135	100	150	110	163	130
9/16"	18	71	57	120	90	150	110	170	130	181	144
5/8"	11	98	78	150	110	140	140	220	170	230	184
5/8"	18	115	93	180	130	210	160	240	180	255	204
3/4"	10	157	121	260	200	320	240	380	280	400	320
3/4"	16	180	133	300	220	360	280	420	320	440	350
7/8"	9	210	160	430	320	520	400	600	460	640	510
7/8"	14	230	177	470	360	580	440	660	500	700	560
1"	8	320	240	640	480	800	600	900	680	980	780
1"	12	350	265	710	530	860	666	990	740	1060	845

METRIC	5.8	8.8	9.8	10.9
Bolt Dia.	Oiled	Oiled	Oiled	Oiled
5mm	3.5	5	6	8
6mm	6	9	10.5	12
8mm	15	22	25	32
10mm	29	44	51	62
12mm	51	76	89	111

Per SAE J1701 and SAE J1701M specifications.

UNIVERSAL FRONT DISC BRAKE CHECKLIST

- [] 1) Spindle Properly secured to ball joints and tie rods with castle nut and cotter pin.
- [] 2) All mounting bolts properly tightened.
- [] 3) Wheel bearings properly packed with grease.
- [] 4) Inner bearing must be installed before grease seal.
- [] 5) Rotor / bearings slide onto spindle with ease.
- [] 6) Washer, castle nut properly torqued and cotter pin installed.
- [] 7) Calipers installed and properly torqued.
- [] 8) Spin rotor and check for any interference. (If any interference is found, resolve problem before driving vehicle.)
- [] 9) Flex lines are properly installed with no interference.
- [] 10) Power booster (if applicable) installed properly.
- [] 11) Master cylinder bench bled according to the instructions.
- [] 12) All brake lines are properly tightened and free of leaks.
- [] 13) Turn wheels lock to lock and check for any interference.
- [] 14) Place wheel onto vehicle and spin the wheel to make sure there is no interference between the brakes and wheel.

UNIVERSAL REAR DISC BRAKE CHECKLIST

- [] 1) All bolts on base bracket properly tightened.
- [] 2) All caliper mounting bolts properly tightened.
- [] 3) Rotor slides onto axle with ease.
- [] 4) No interference with rotor and any other parts (splash shield, brackets, etc.).
- [] 5) Caliper is centered over the rotor (because of difference in axle lengths, you may have to shim caliper in or out).
- [] 6) No interference with caliper and rotor.
- [] 7) All brake lines are tight with no leaks.
- [] 8) Parking brake is properly adjusted and not dragging, with vehicle on ground.
- [] 9) Adjustable proportioning valve installed (if applicable).
- [] 10) Distribution block modification made (if applicable).
- [] 11) Brake system properly bled.



WITH EVERY NEW SET OF ROTORS AND PADS, YOU SHOULD GIVE YOUR VEHICLE 200 - 250 MILES OF EASY DRIVING TO PROPERLY SEAT THE PADS TO THE ROTORS. DO NOT TAKE THE VEHICLE UP TO 60 MPH AND JAM ON THE BRAKES BEFORE THE FIRST 200 - 250 MILE BREAK IN PERIOD IS OVER, OR YOU WILL GLAZE THE PADS AND ROTORS.

TECHNICAL SUPPORT / WARRANTY POLICY

You have just purchased a high quality product manufactured by Stainless Steel Brakes Corporation. To ensure proper installation, please read all instructions thoroughly before beginning your work. In most applications, your kit will install as the instructions indicate. From time to time, the original equipment on some vehicles may have slight variations that can effect the ease of installation. Minor modifications during installation may be necessary to successfully install your kit. If modifications are necessary, please refer to a licensed mechanic and/or contact our technicians for modification approval.

Installation of braking, steering and suspension components and systems require proper procedures and methods to assure safe and correct operations.

Always test completed installations in a safe area. For proper operation, and if questionable, correct prior to placing the vehicle in service.

Our company maintains experienced technical service personnel, including a licensed professional engineer who have the knowledge and background to help you with installation or operating problems. Our technicians may be reached by telephone at 716-759-8666, Monday - Friday, 9:30 AM - 5:30PM EST. If unavailable, please leave a brief message, including your day phone number, and they will return your call as soon as possible. You can also e-mail us at tech@ssbrakes.com. If you prefer, we will be pleased to speak with your installing mechanic.

If it becomes necessary to return an item for any reason, a Return Goods Authorization (RGA) Number must first be obtained by telephone. A simple written description of the reason for the return should be included with the part. Your name and phone number should also be included. (Use the attached form.) "Defective" is not enough of a description. See following page for detailed instructions.

We urge you not to disassemble or alter any part supplied, nor purchase additional parts or services in order to facilitate installation. Lack of prior approval by our company will constitute a violation of our warranty with consequent denial of reimbursement for parts - faulty or not.

Before contracting outside professional assistance, please be aware that we do not reimburse for labor charges under any circumstance. Consult our standard warranty card provided with your order.

NEED TO RETURN A PART? FOLLOW THESE INSTRUCTIONS.

- > Did you call our Technical Assistance (716-759-8666) before you decided to make a return? If not, you should do so now.
- > You must have a Return Goods Authorization Number (RGA) issued to you prior to returning any item. If you return without an RGA #, you run the risk of not receiving credit.
- > Make sure to include the completed Return Form with invoice and RGA # with your parts.
- > Whenever possible, please return item in original box with invoice and RGA # clearly marked on the outside of the box.
- > Any return must be shipped postage paid - NO collect shipments will be accepted.
- > All warranty items will be sent ground UPS. Any other type of shipping service will be at customer's expense.

It is a good idea to insure the returned part(s) for the full value to protect yourself against loss. We strongly suggest you ship by UPS or U.S. Mail, no BUS or AIR shipments will be accepted. All foreign returns must have authorization.

NOTE: Under no circumstance should any product(s) or part(s) be returned without prior authorization number (RGA #). Any part which, in our opinion, shows evidence of being used, installed contrary to SSBC instruction, defaced, subjected to improper handling, packaging or shipping by the customer will not be eligible for exchange, refund or warranty consideration.

RETURN FORM

Name: _____

Invoice #: _____

Address: _____

Date Purchased: _____

Purchased From: _____

Phone: _____

List item(s) and a detailed explanation of why you are returning the item(s):

RGA # _____



Use this label for your package.

From: _____ _____ _____	
TO: Stainless Steel Brakes Corp. 11470 Main Road Clarence, NY 14031	
RGA #: _____	Invoice #: _____